

# **WS-GP1** Weather Station

*WS-GP1 Weather Station for wind speed and direction, relative humidity, air temperature, rain and solar radiation*

## **Quick Start Guide** Version 2.0



**AT** *Delta-T Devices Ltd*

# Introduction

The WS-GP1 Weather Station measures wind speed and direction, air temperature, relative humidity, solar radiation and rainfall.

Apart from the wind vane tail, the sensors are already attached to the cross-arm and connected to a GP1 Logger with a weather station program installed.

This guide explains how to choose a site, install the mast, mount and align the cross arm, add the wind-vane tail and align it to North. Then, using a PC or Windows Mobile Device we show how to change the weather station program, check the sensor readings, then acquire and display readings.

## 1 Unpacking

Check your contents against your order.

You should have a cross arm fitted with a **GP1** logger pre-wired to:

- Wind speed and direction sensor **D-034B-CA**
- RH and air temperature sensor **RHT3ni-CA**
- Solar energy flux sensor **PYRPA-03**
- Rain gauge **RG2+WS-CA**

You should also find the following:

- Sensor user manuals
- GP1 Quick Start Guide and screwdriver
- Allen keys - 5/64 inch for the wind vane and 2.5 mm for light sensor levelling mount
- Spanner for the mast
- GP1-RS232 serial cable
- Delta-T Software and Manuals CD including DeltaLINK PC version 2.3 or later

You may also have the following:

- Tripod mast M2-TRPD or some other mast to mount on
- Guy wire support kit WS-GWSK

Other tools you may need:

- Spirit level for ensuring mast is vertical
- Pick axe and shovel if the site needs preparing for the mast
- Mallet for ground stakes if used
- Steps, box to stand on, or mirror, to see bubble level on light sensor
- PC running DeltaLINK-PC or PDA running Pocket DeltaLINK version 2.3 or later

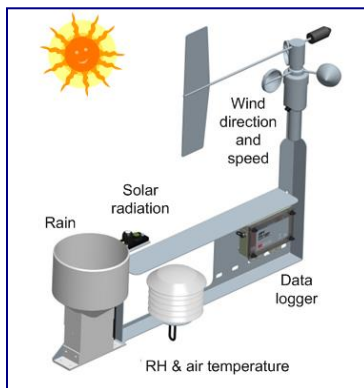

## 2 Choose the Location

Results depend not just on sensor accuracy and reliability but also on how representative the site is – so choose the site carefully.

Where data is to be compared to a “standard” meteorological site, the sensors should be exposed in a similar way to sensors at the standard sites, i.e. over a level surface of short grass and away from trees or buildings.

*These are rough guidelines. Refer to meteorological publications for further advice.*  
e.g. <http://www.wmo.int/web/www/IMOP/WebPortal-AWS/Index02.html>

### Rules of thumb

Near a building, mount the sensors outside the zone of influence. Horizontally this extends roughly twice the height of the building upstream and ten times downstream. Vertically it extends to about twice the height of the structure.

If the requirement is to measure the true local conditions, e.g. a field of newly planted corn, select a relatively uniform area of the terrain. Be aware that, as a crop grows up towards the sensors, the measured wind speed decreases as the canopy approaches.

Sensors are also influenced by the changing local thermal and humidity microclimate above the crop. There are no simple rules to follow – but be aware of the following:

**Clothes line effect:** vegetation upwind may affect vapour gradients and heat transfer.

**Oasis effect:** If an isolated source of water, e.g. a lake or glacier, is surrounded by a relatively arid area, then the relative humidity may be affected if the wind direction draws air from the water source.

**Leading Edge effect:** When air moves over the boundary between two surfaces that differ in temperature, moisture content, roughness or some other characteristic, it takes time for the air to adjust. The line of discontinuity is known as the leading edge. The boundary layer will vary in vertical extent with distance from the leading edge as it adjusts to the new conditions.

**Thermal plume effect:** Avoid placing objects directly under the air humidity and temperature sensor, such as a solar panel, which can create a rising thermal plume when warmed by the sun.

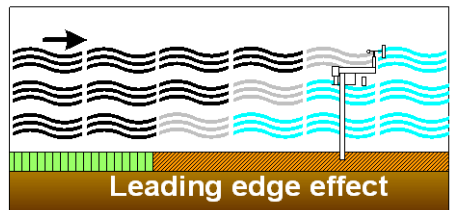
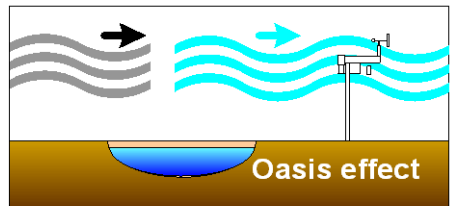
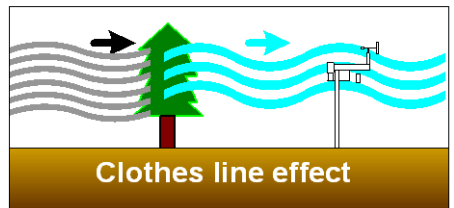
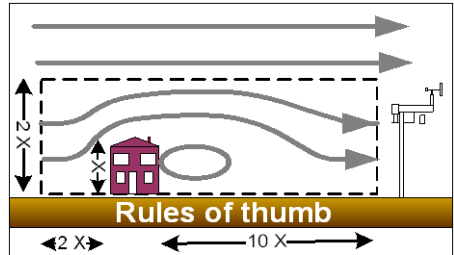

### 3 Attach wind vane

- 1 Fully insert vane arm into hub.
- 2 Align vane with centre axis of sensor.
- 3 Use the hex 5/64" Allen key to tighten the set screw at the top of the hub.

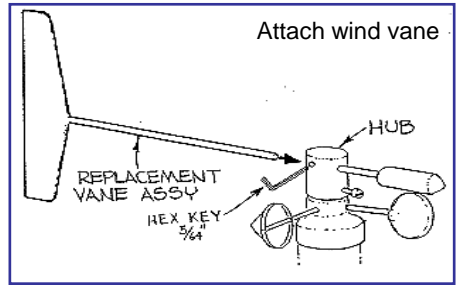

### 4 Install mast and cross arm

The cross arm can be mounted on any sturdy vertical (or horizontal) mast of diameter: 42 to 52 mm (1½ to 2 inches).

Make the ground sufficiently level, firm and stable to secure your mast. If using the M2-TRPD tripod mast use the optional guy wire kit with ground stakes to further stabilise it.

Install the mast securely and as vertical as possible using a spirit level.

Shield the logger from direct sun by mounting the cross arm East to West with the logger away from the Equator.

If using a solar panel, ensure it is not immediately below the RH and air temperature sensor.

Bolt cross arm to the mast - using the U-bolts and box wrench, and make it horizontal.

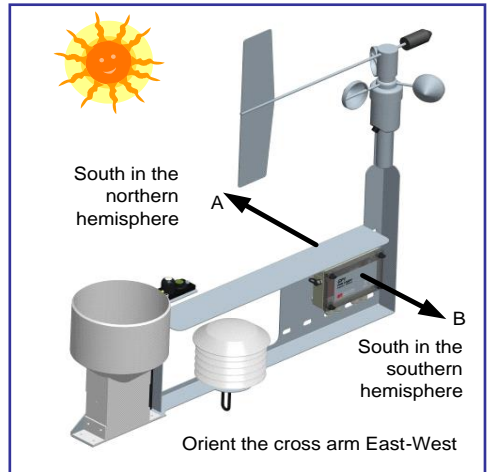

### 5 Orient the wind vane

#### Find true north

It is best to set the wind direction sensor to true north, not magnetic north.

**Compass Method:** Get a compass and the local angle of magnetic declination – either from a map, local airport - or use an online calculator e.g.

<http://www.ngdc.noaa.gov/seg/geomag/jsp/struts/calcDeclination>

...and enter your latitude and longitude.

Magnetic declination (or variation) is the angle between magnetic north and true north.

It is positive when the angle measured is east of true north and negative when west. So, if the declination is positive, true north is left of magnetic north.

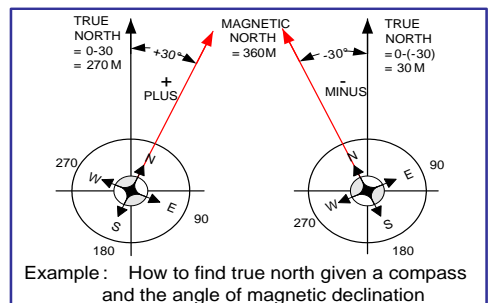

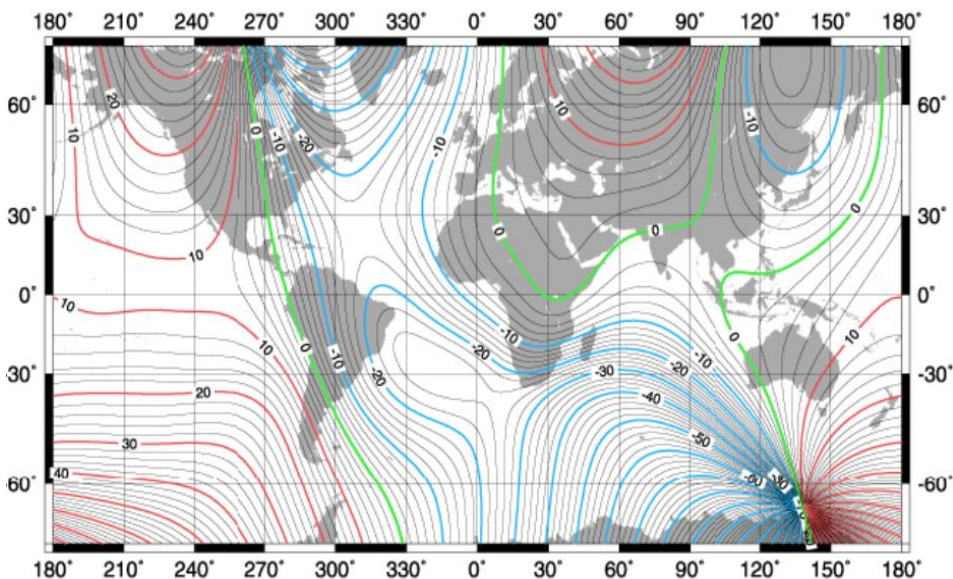

**Typical map of magnetic declination for year 2000**

*(reproduced courtesy of NOAA)*

From this map you can see the magnetic variation around the world can be quite large. Magnetic north also drifts over time, so it is best to refer wind direction to true north.

**Star Method:** Find the North Star or the Southern Cross.

Whichever method you use, establish where True North intersects the horizon.

## ***Orient the wind vane***

1. Ensure that the locking **shoulder screw #23<sup>1</sup>** is in place on the hub. The wind vane cannot rotate and, if read, the sensor should indicate 180 degrees, i.e. south.
2. Using the spanner provided, loosen the clamp holding the O34B to the cross arm,
3. Rotate the housing body until the counterweight and the black arrow on the housing actually point to true south (and the wind vane tail points to true north).
4. Tighten the clamp and remove the shoulder screw to release the wind vane and allow it to rotate freely.

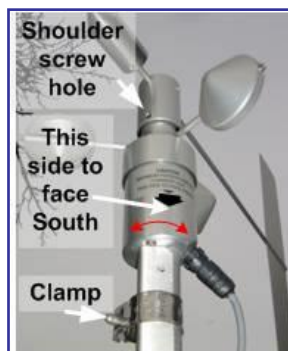

## ***6 Level the light sensor***

Adjust the tripod of screws supporting the light sensor to centre the bubble level, using the 2.5 mm hexagonal socket wrench provided .

*Note: You may need to stand on steps or a box or use a mirror to see the bubble level.*



<sup>1</sup> See the D-034-CA Technical Manual on the Software and Manuals CD

## 7 Install and Start GP1 Software



Install and start the GP1 software DeltaLINK on your PC as instructed in the GP1 Quick Start Guide and connect to the Weather Station GP1 logger using the GP1-RS232 cable provided.

## 8 Examine the GP1 Program

1. Select the **Program** window. Factory installed weather stations will have the **WS-GP1 Weather Station Program** pre-installed as shown

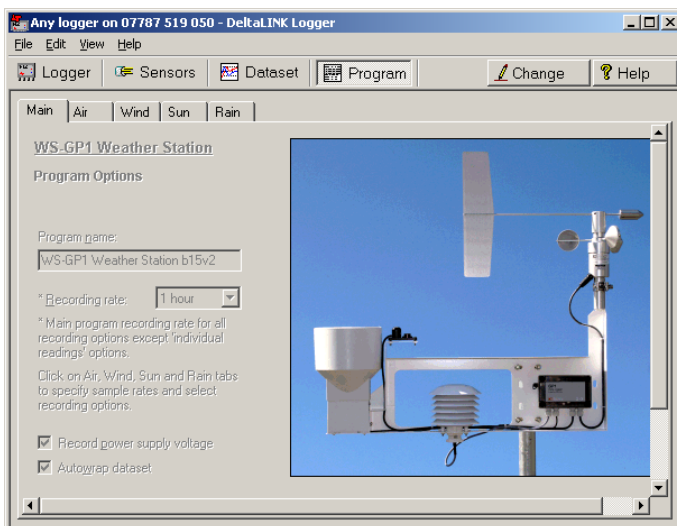

2. If missing, to reinstall this program Click **Change** on the **Program** window and select **File, New Program, WS-GP1 Weather Station Program** and click **OK**.
3. Click on and examine the **Air, Wind Sun** and **Rain** sensor tabs.
4. Examine the context sensitive online **Help** for each tab.
5. Note the default 1 hour Recording Rate in the Main tab and the choice of faster sampling rates for individual sensors in the Sensor tabs, and modify them as required.
6. Note the various recording options such as **Average, Maximum, Time of maximum** and so on, and click the check boxes as required.
7. Note the choice of units for wind run and radiation integral.
8. Make any change you deem necessary to the program and click **Apply** to install it to the logger.

For definitions e.g. for the various wind rose options: see the online **Help**.

Recording options		
Label	Units	Description
<input checked="" type="checkbox"/> AirTemp	deg C	Air temperature, individual readings
<input checked="" type="checkbox"/> AirTemp.Avg	deg C	Air temperature, average
<input checked="" type="checkbox"/> AirTemp.Min	deg C	Air temperature, minimum
<input type="checkbox"/> AirTemp.Tmin		Air temperature, time of minimum
<input checked="" type="checkbox"/> AirTemp.Max	deg C	Air temperature, maximum
<input type="checkbox"/> AirTemp.Tmax		Air temperature, time of maximum
<input type="checkbox"/> AirTemp.Std	deg C	Air temperature, standard deviation
<input checked="" type="checkbox"/> RH	%	Relative humidity, individual readings
<input checked="" type="checkbox"/> RH.Avg	%	Relative humidity, average
<input checked="" type="checkbox"/> RH.Min	%	Relative humidity, minimum

## 9 Check sensors & start logging

1. Select the **Sensors** window and click the **Read now** button. The sensor readings will continually refresh on a scrolling time graph.
2. Observe the sensor reading display in the scrolling charts and value panels.
3. Check the wind vane reads 360 degrees at north and 180 at south.
4. Spin the anemometer and blow on the radiation shield and check the readings look plausible.
5. Illuminate the light sensor then cover it, and check the readings seem plausible.
6. Pour water into the rain gauge funnel to simulate rainfall.
7. Click the **Cancel** button when finished.
8. Select the **Logger** window and click **Start** to commence logging.

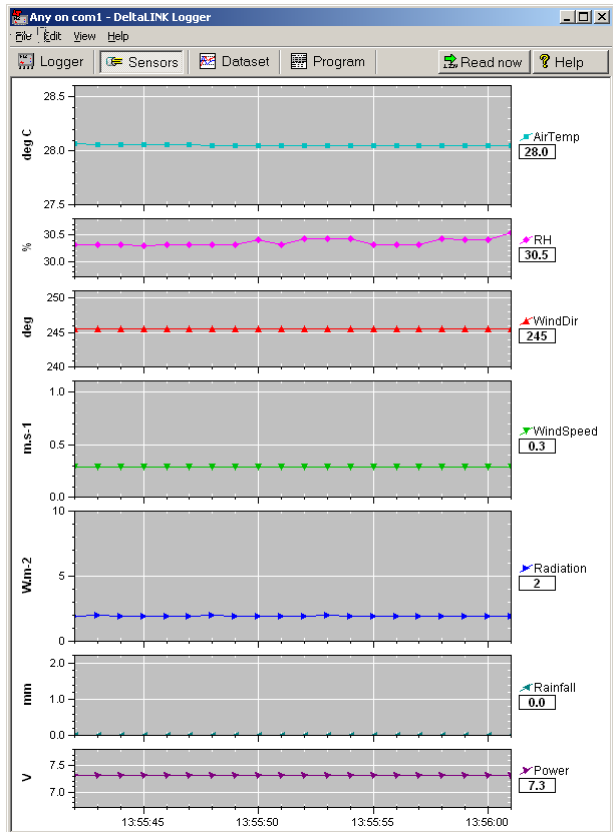

For help diagnosing sensor behaviour - from the **Help** menu (Alt H) select **Document Library** (Alt D), and then **WS-GP1** to display the Weather Station Document Library and refer to the individual sensor technical manuals.

## Weather Records

### 10 Collect and Save Logged Data

1. Select the **Dataset** window. All stored data in the logger will be retrieved and displayed on the screen (it may take a few seconds to download the data). Click **Refresh** if required.
2. Select **File, Save** to save the data to a dataset file.
3. Select **File, Open** to open and view a previously saved dataset file.
4. To save a dataset file as a ASCII file for importing into other programs, open the file in DeltaLINK, and select **File, Save As...** selecting the appropriate file type to save.

# 11 View Weather

## Display Options in Dataset View

Right-click on the timescales axis to select from the preset timescale options.

Left click and drag on a chart to mark out a zoom region. Then right-click to zoom.

Right click on the value axis to restore the default zoom.

Left click and drag top and bottom chart borders then click to resize the chart

Right click on the chart region to pop up a menu of display options including **Hide**, **Show all Charts** and **Details** options

See also the online **Help**

## Example Dataset

From the **Help** menu (Alt H) select **Document Library** (Alt D), and then **WS-GP1** to display the Weather Station Document Library

Double click on the file "**Example WS-GP1 Weather Station data.dt6**" to display a typical record.

Examine the display options as outlined above.

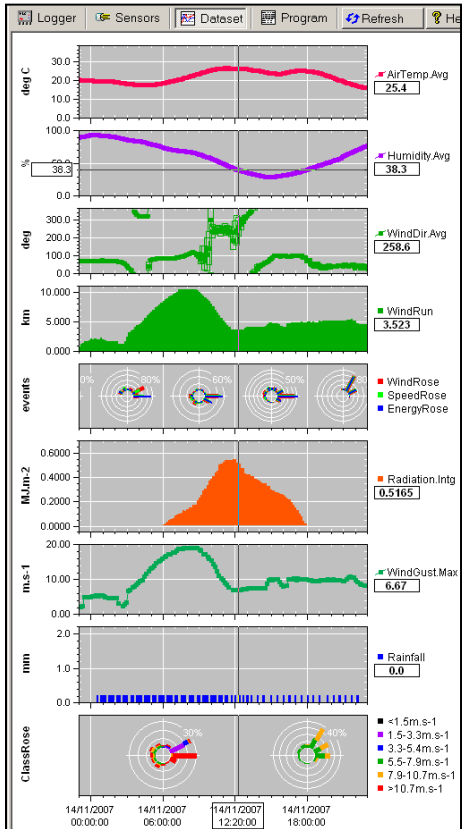

Note – Statistical symbols are only available if selected in the program

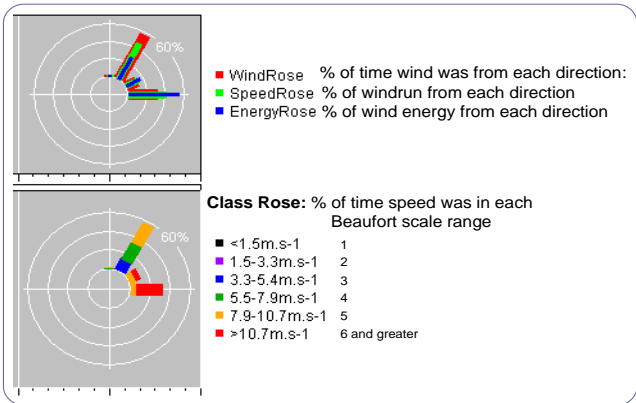
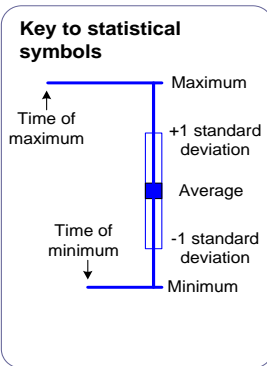



## Further processing your weather data

**Dataset Import Wizard** helps you seamlessly import data into MS Excel spreadsheets. Multiple dataset files may be imported and the data interleaved.

See **GP1 Quick Start Guide** for instructions on using the Dataset Import Wizard.

Once your data is in Excel, many third-party Excel add-ins are available to help you process your database.

Note: at the time of writing this document Excel can only graph up to 32000 lines of data.

## Moving the station

For its protection, remove the wind sensor vane before moving the weather station.

The **blue box is NOT drop proof**, so carry it carefully. Do not ship it by commercial carrier without further protective packing.

## Battery Life

**Replace the battery before the battery voltage indicator drops below 5.5V.**

At 1 reading/ minute on all sensors a 9V Alkaline battery may last 90 days.

To increase this, reduce the reading frequency, and/or use a lithium battery or external lead acid battery.

The RH sensor dominates the current consumption - reducing RH sensor readings to once every 5 minutes will more than double battery life.

You might expect an external 10 Ahr lead acid battery to last longest, but internal self discharge may limit this to 12 months at 25°C or only 3 months at 40°C. So unless it is periodically recharged – for example by a solar panel - a lead acid battery may not outlast a Lithium battery with its longer shelf life.

Note: When retrieving data, keep an eye on your logger battery. Its status is reported by the logger software, and you can also log it along with the sensor readings. The voltage reported is that presented to the sensors, and is slightly less than that at the battery terminals.

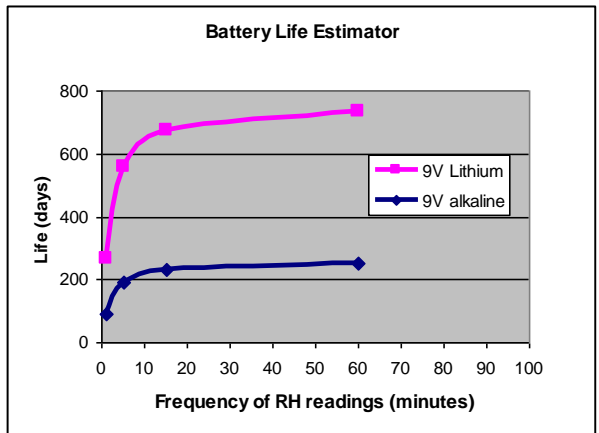

# Specifications

	Specification	Range/Notes
<b>Logger GP1</b>		
Accuracy analog	$\pm (0.3\text{mV}+0.01\% \text{ reading})$	typical at 20°C
	$\pm (1.63\text{mV}+0.05\% \text{ reading})$	max over -20°C to + 60°C
Temperature accuracy	$\pm 0.07\text{°C}$ typical at 20°C	for 10K thermistor (at -20 to + 60°C)
	$\pm 0.13\text{°C}$ max. (-20°C to +60°C)	
Readings	> 600,000	
Logging frequency	1s to 24 hr	
Data collection	To PC or Pocket PC	
Logging status	Flashing LED	
Environmental	-20°C to +60°C, IP67	
<b>Wind speed</b>		
Accuracy	$\pm 0.1\text{m.s}^{-1}$	up to $10\text{m.s}^{-1}$ (22.7 mph)
	$\pm 1.1\%$ of reading	over $10\text{m.s}^{-1}$ (22.7 mph)
Range	0 to $75\text{m.s}^{-1}$ (0 to 167 mph)	
Starting threshold	$0.4 \text{m.s}^{-1}$ (0.9 mph)	
<b>Wind direction</b>		
Accuracy	$\pm 4\text{°}$	
Range	0 to 356°	electrical
	0 to 360°	mechanical
Starting threshold	$0.4 \text{m.s}^{-1}$ (0.9 mph)	
Damping ratio	.25	
Resolution	< 0.5°	
<b>Temperature</b>		
Accuracy at 25°C	$\pm 0.2\text{°C}$	sensor and logger
	IP65	
Radiation Shield error	0.5 °C	at $3 \text{m.s}^{-1}$
	1.0 °C	at $2 \text{m.s}^{-1}$
	2.0 °C	at $1 \text{m.s}^{-1}$
<b>RH</b>		
Accuracy at 25°C	$\pm 2\% \text{ RH}$	5 to 95% RH
	$\pm 2.5\% \text{ RH}$	< 5% and > 95% RH
Environmental	-20 to 80°C, 0-100%RH	IP65
Response time	< 10s	90% of scale for a step change from 11% to 75% RH
<b>Rainfall</b>		
Sensitivity	0.2mm per tip	up to $360 \text{mm.hr}^{-1}$
<b>Solar Radiation</b>		
Calibration Uncertainty	$\pm 5\%$	
Spectral Range	360 to 1120 nm	response exceeds 10% of maximum
Cosine response	$\pm 5\%$	75° zenith angle
Drift	<2% per year	
Environmental	-40 to 70°C, 0 to 100%RH	can be immersed up to 30m in water

# Sensor Wiring

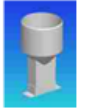

		Colour	Function	GP1 connection
<b>Wind speed &amp; Direction:</b>				
Pin 1	D-034B-CA Wind speed and direction	Red	WS signal	Event 5
Pin 2		Black	WS common	GND
Pin 3		Yellow	WD signal	Temp3 (IN)
Pin 4		Green	WD Common	Temp3 (GND)
Pin 5		White	WD +REF	+5V (ref)
		White/brown	Shield	GND
<b>Temperature &amp; RH</b>				
	RHT3nl-CA Temperature and RH	White	RH Signal+	CH2 (+)
		Green	RH Signal -	CH2 (-)
		Blue	Air temp +	Temp4 (IN)
		Yellow	Air Temp -	Temp4 (GND)
		Red	Power V+	CH2 (PWR)
		Black	Power V-	CH2 (GND)
		Screen	Shield	GND
<b>Rainfall</b>				
	RG2	either	Switch NO	Event 6
	Rain	either	Switch common	GND
<b>Solar Radiation</b>				
	D-PYRPA-CA pyranometer	Red	5V power	+5V (ref)
		Black	Ground	CH1 (GND) + CH1(-)
		White	Signal	CH1 (+)
		Clear	Ground	CH1 (GND) + CH1(-)

## Service & Recalibration

Before returning parts please contact Delta-T or your local agent for instructions.

### Wind speed and direction D-034B-CA

**Recalibrate:** every year. **Service:** 6-12 months: look & listen to see if the vane and cups are running freely, are undamaged, and are not loose. 12-24 months: replace anemometer bearings. 24-36 months: complete factory overhaul of sensor. Most parts are replaceable in the field.

Note: the Windvane, though connected to GP1 terminal Temp3, is actually read as a voltage output sensor (0-2.5V equals 0-360 degrees). The internal circuit differs from the standard MetOne O34B, see panel at right.

See also **D-034B-CA Technical Manual** on the Delta-T Software and Manuals CD.

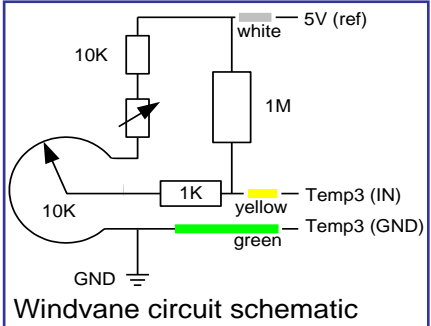

## Rain gauge RG2

Can be recalibrated in the field.

See also the **RG2+WS-CA Technical Manual** on the Software and Manuals CD

## Light sensor D-PYRPA-CA

Typical drift 1% per year. Recalibrate every 2 years. Keep it clean and level.

Manufacturer's Warranty: 1 year parts and labour.

See also the **D-PYR-PA Technical Manual** on the Software and Manuals CD

## RH & air temp sensor RHT3nl-CA

Typical drift -1.5 to -2% in the first year, -1% in the second year and -0.5% in the third. No adjustment of the RH or temperature element is possible. Inaccurate sensors must be replaced with new module which can be plugged in the field. Replace every two years in clean atmospheric conditions or every year if the atmosphere is polluted.

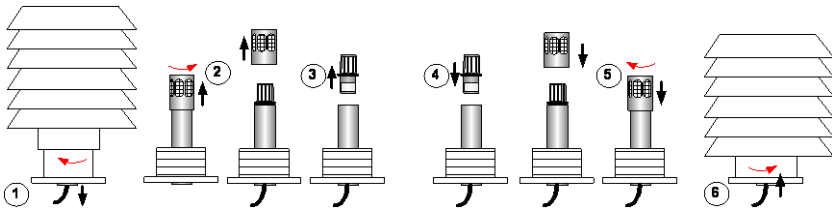

## Replacing the RH Sensor

Note: the RHT3nl uses a 10K Betatherm 10K3A1B thermistor and a 6 plate radiation shield but is otherwise similar to the RHT2nl sensor.

See also the **RHT3nl-CA Technical Manual** on the Software and Manuals CD.

## Notices

This product uses software code. It should not be used in safety-critical applications or where consequential loss may occur. It is the responsibility of the user to ensure appropriate safeguards are in place for regularly monitoring and checking the equipment.

In no event shall Delta-T's liability exceed the selling price of the product. Delta-T is not liable for indirect, incidental or consequential damages in connection with the use of equipment, including but not limited to: data loss, vegetation loss, loss of energy or water, cost of substitute equipment or services, property damage, or personal injury that results from installer's negligence. The customer agrees to the limitations and exclusions of liability by purchase or use of this product. See also the GP1 **Product Usage.pdf** in the online **Document Library** folder.

The WS-GP1 Weather Station is CE compliant, See **WS-GP1 EC Certificate.pdf** in the online **Document Library** folder.



Delta-T Devices Ltd  
130 Low Road, Burwell  
Cambridge CB25 0EJ  
UK

Tel: +44 1638 742922  
Fax: +44 1638 743155  
e-mail: [sales@delta-t.co.uk](mailto:sales@delta-t.co.uk)  
[tech.support@delta-t.co.uk](mailto:tech.support@delta-t.co.uk)  
web: [www.delta-t.co.uk](http://www.delta-t.co.uk)